



88 (3.5")

35 (1.4")



35  
(1.4")

adjustable  
up to 3000  
(10')  
standard

adjustable  
up to 30500  
(100')  
custom



150-191  
(5.5'-7.5')

PENDANTS: one

MOUNTING: mini innie canopy (mud-in), 35mm (1.4") in diameter (exposed), 88mm (3.5") in diameter (overall) x 35mm (1.4")

LAMPING: 1.5w LED (2000K, 2500K, 3500K)

COAX: adjustable 3000mm (10') standard / up to 30500mm (100') maximum

MATERIALS: blown glass, braided metal coaxial cable, electrical components, white polyurethane canopy

WEIGHT: approximately 2.75kg (6.1lb)

POWER SUPPLIES: remote mounted (fixture does not hook directly to a junction box). Power supplies included

#### DESCRIPTION

The 100.1mi is a single 100 pendant fixture with a mini innie canopy size. The mini innie canopy is 35mm (1.4") in diameter (exposed), 88mm (3.5") in diameter overall, and 35mm (1.4") deep, which is meant to be mudded into drywall. The pendant drop lengths on this light fixture are adjustable up to the specified maximum. Note: not adjustable after drywall is finished.

100 brings multiple glass artists together in a performative act. Molten glass bubbles are prepared and then smashed together to produce unpredictable interlocking glass forms.

#### NOTES

- + Purchase replacement lamps online at [www.bocci.com/shop/bulbs](http://www.bocci.com/shop/bulbs)
- + All chandeliers will be outfitted with 2500K lamps if not specified.
- + Requires power supplies to be remote mounted.

US Patent Pending  
EU Patent # 008526131-0001

Made in Vancouver, Canada

Vancouver  
[sales@bocci.com](mailto:sales@bocci.com)  
[www.bocci.com](http://www.bocci.com)

Berlin  
[europe@bocci.com](mailto:europe@bocci.com)  
[www.bocci.com](http://www.bocci.com)

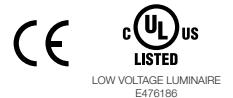

MINI INNIE CANOPY

# 100.1mi

PRODUCT SPECIFICATION

© 2021, Bocci Design and Manufacturing Inc. All rights reserved. Any inquiries should be directed to: [info@bocci.com](mailto:info@bocci.com)

# BOCCI

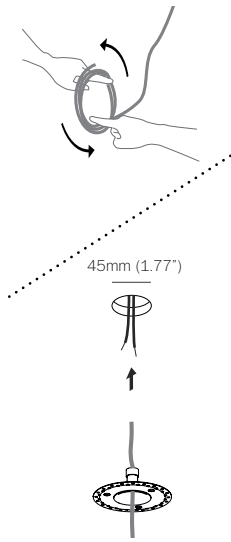

1

Very carefully uncoil the braided coaxial cable in a spool like manner. Insert your index fingers into opposite sides of the roll then rotate your fingers around each other to unroll the coaxial cable.

Use patience: allow the cable to uncoil completely to avoid kinks.

Thread the coaxial cable through the canopy.

Drill a 45mm (1.7") diameter hole in ceiling material. Pull low voltage house wire through the hole.

**Note:** This low voltage wire will run to a remote mounted power supply.

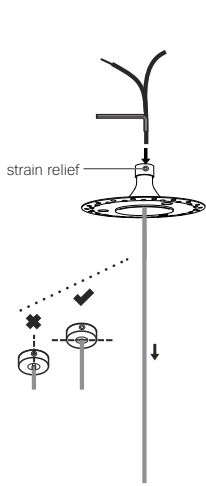

2

Determine the overall drop for the pendant fixture. Use the 2mm Allen key to loosen the setscrew in the canopy and gently feed the cable through until you have reached your desired drop length.

Use Allen key to tighten the setscrew to hold the strain relief and secure the coaxial cable at its new length. Perform a gentle tug test to ensure it is secure.

**DO NOT OVERTIGHTEN.**

**Note:** The strain relief is a black plastic collar around the coaxial cable. There is a single slot opening on the side of the strain relief component. It is essential that this opening is oriented at 90 degrees to set screw chamber. There can be no contact between the set screw and the cable.

RISK OF ELECTRIC SHORT!

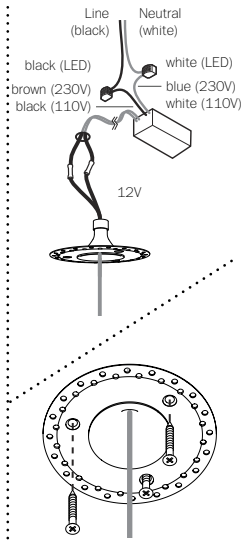

3

Connect the black wire to black and white wire to white wire.

Connect the house wires to the coaxial cable using #16 butt splices (stagger the splices). Use raw butt splices and heat shrink to simplify the installation.

For multiple pendant installations, ensure that the braided outer wires are all connected to one 12V output wire and all inner insulated wires are connected to the other or a short will occur.

**Note:** Insulated core is positive and braided exterior is negative.

Affix mini innie canopy to ceiling surface with fasteners provided.

Turn power to fixture on.

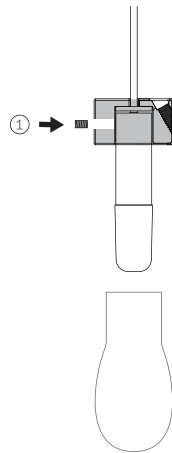

4

Step 1: Attach the lamp holder to the pendant hardware with set screw provided.

Plug the lamp into lamp holder and slide on the diffuser. Do not touch the lamp with your bare hands. Ensure power to lamp is working correctly.

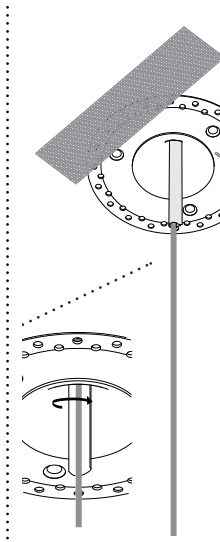

5

Tape the mounting plate edges with fiber mesh drywall tape.

**Note:** mask the coaxial cable off with painters tape to help with cleanup.

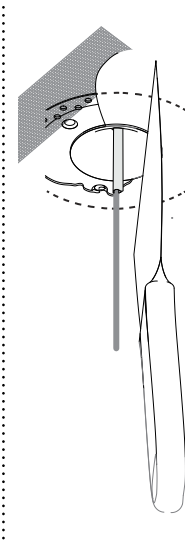

6

Use a drywall filler compound to "mud over" the assembly. Use the raised edge to mud up to to establish a sharp edge and to avoid getting mud in the indentation

Feather from the center of the mounting plate outwards using a large drywall trowel.

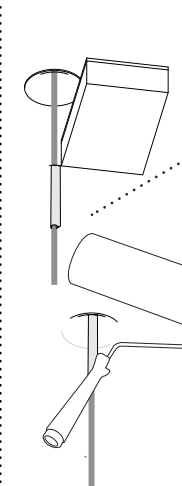

7

Using a foam sanding block, sand entire area until the rim and the edge of the operative component are exposed. For long term performance, it is essential that mud is sanded right down to the plastic rim.

Paint over entire assembly.

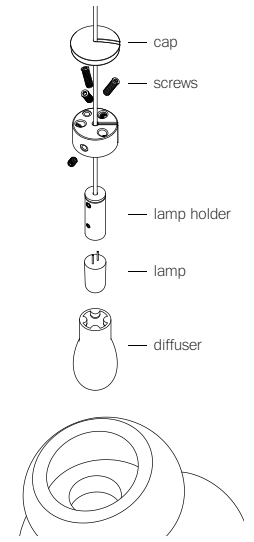

8

**Please note that the crisp cut edges of the 100 pendants are fragile and can chip if not handled with care when installing and cleaning.**

**Bocci recommends wearing gloves during the installation. The edges of the glass may be sharp to handle.**

MINI INNIE CANOPY

100.1mi

PRODUCT INSTALLATION INSTRUCTIONS

© 2021, Bocci Design and Manufacturing Inc. All rights reserved. Any inquiries should be directed to: info@bocci.com

**BOCCI**

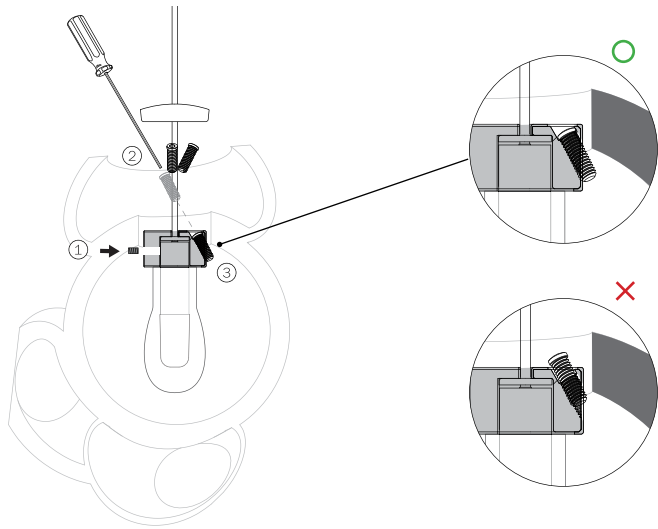

9

Step 2: Insert the pendant hardware assembly into the pendant.

Step 3: Tighten the 3 screws until they are fully engaged (refer to illustration above).

10

Give the pendant a gentle pull to ensure the screws are locked onto the pendant.

Slide cover cap onto the coaxial cable and place into the inset portion of the pendant hardware.

11

The cap should sit flat on the pendant hardware.

If the screws are sticking out and the cap isn't sitting flat on the pendant hardware, please check to ensure the screws are fully engaged.

Refer to step 8 & 9 for more details.

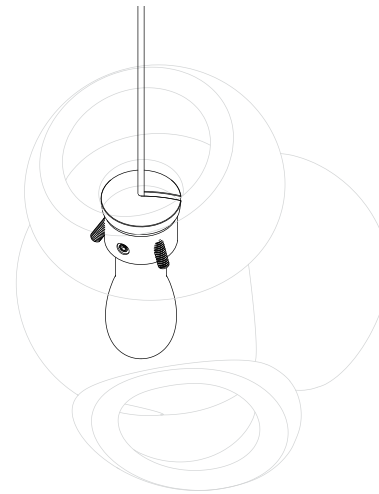

12

Clean fingerprints from surfaces.

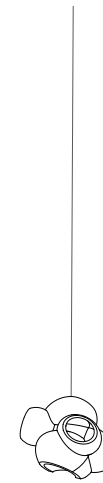

For additional assistance,  
please contact Bocci:

Vancouver  
sales@bocci.com  
www.bocci.com

Berlin  
europe@bocci.com  
www.bocci.com

US Patent Pending  
EU Patent # 008526131-0001

Made in Vancouver, Canada



LOW VOLTAGE LUMINAIRE  
E476186

MINI INNIE CANOPY

100.1mi

PRODUCT INSTALLATION INSTRUCTIONS

© 2021, Bocci Design and Manufacturing Inc. All rights reserved. Any inquiries should be directed to: info@bocci.com

**BOCCI**